

SCONCES

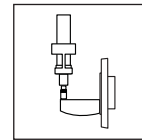

TARGIT SCONCE
100 580ch/mc
100 580mc

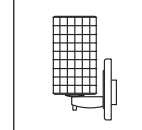

SIERRA SCONCE
100 114bz
100 114ch
100 114mc

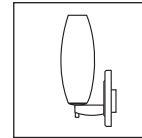

CIRO SCONCE
100 116(bz, ch, mc)
100 118(bz, ch, mc)
100 119(bz, ch, mc)
100 121(bz, ch, mc)
100 122(bz, ch, mc)
100 123(bz, ch, mc)
100 124(bz, ch, mc)
100 125(bz, ch, mc)

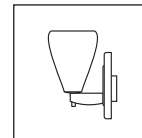

LUCY SCONCE
100 126(bz, ch, mc)
100 127(bz, ch, mc)
100 128(bz, ch, mc)

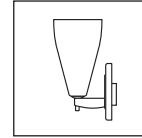

ZARA SCONCE
100 151(bz, ch, mc)
100 152(bz, ch, mc)
100 153(bz, ch, mc)
100 154(bz, ch, mc)
100 156(bz, ch, mc)
100 157(bz, ch, mc)

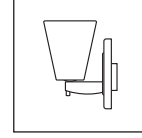

BLING SCONCE
100 168(bz, ch, mc)
100 173(bz, ch, mc)
100 178(bz, ch, mc)
100 840(bz, ch, mc)
100 841(bz, ch, mc)
100 842(bz, ch, mc)

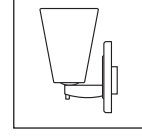

BLING SCONCE II
100 169(bz, ch, mc)
100 174(bz, ch, mc)
100 179(bz, ch, mc)



BOLERO SCONCE
100 336(bz, ch, mc)
100 337(bz, ch, mc)
100 338(bz, ch, mc)
100 339(bz, ch, mc)



RAINBOW SCONCE
100 721(bz, ch, mc)
100 722(bz, ch, mc)
100 723(bz, ch, mc)
100 724(bz, ch, mc)
100 913(bz, ch, mc)
100 918(bz, ch, mc)

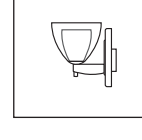

RAINBOW SCONCE
100 725(bz, ch, mc)
100 726(bz, ch, mc)
100 728(bz, ch, mc)
100 729(bz, ch, mc)
100 816(bz, ch, mc)
100 817(bz, ch, mc)
100 916(bz, ch, mc)
100 919(bz, ch, mc)

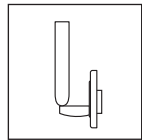

CHIANTI SCONCE
100 820(bz, ch, mc)
100 821(bz, ch, mc)
100 822(bz, ch, mc)
100 823(bz, ch, mc)

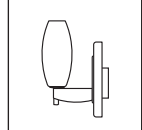

CIRO MINI SCONCE
100 830(bz, ch, mc)
100 831(bz, ch, mc)
100 832(bz, ch, mc)
100 833(bz, ch, mc)

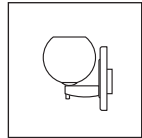

BOBO SCONCE
100 915(bz, ch, mc)
100 917(bz, ch, mc)

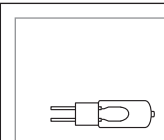

LAMP TYPE: Bi-Pin

MAX WATTAGE: 50W

SOCKET TYPE: GY6.35

VOLTAGE: 12V

TARGIT SCONCE
100 580ch/mc
100 580mc

SIERRA SCONCE
100 114bz
100 114ch
100 114mc

CIRO SCONCE

100 116bz
100 116ch
100 116mc
100 118bz
100 118ch
100 118mc
100 119bz
100 119ch
100 119mc
100 121bz
100 121ch
100 121mc
100 122bz
100 122ch
100 122mc
100 123bz
100 123ch
100 123mc
100 124bz
100 124ch
100 124mc
100 125bz
100 125ch
100 125mc

LUCY SCONCE

100 126bz
100 126ch
100 126mc
100 127bz
100 127ch
100 127mc
100 128bz
100 128ch
100 128mc

ZARA SCONCE

100 151bz
100 151ch
100 151mc
100 152bz
100 152ch
100 152mc
100 153bz
100 153ch
100 153mc
100 154bz
100 154ch
100 154mc
100 156bz
100 156ch
100 156mc
100 157bz
100 157ch
100 157mc

RAINBOW SCONCE

100 721bz
100 721ch
100 721mc
100 722bz
100 722ch
100 722mc
100 723bz
100 723ch
100 723mc
100 724bz
100 724ch
100 724mc
100 913bz
100 913ch
100 913mc
100 918bz
100 918ch
100 918mc

BOBO SCONCE

100 915bz
100 915ch
100 915mc
100 917bz
100 917ch
100 917mc

RAINBOW SCONCE II

100 725bz
100 725ch
100 725mc
100 726bz
100 726ch
100 726mc
100 728bz
100 728ch
100 728mc
100 729bz
100 729ch
100 729mc
100 816bz
100 816ch
100 816mc
100 817bz
100 817ch
100 817mc
100 916bz
100 916ch
100 916mc
100 919bz
100 919ch
100 919mc

BLING SCONCE

100 168bz
100 168ch
100 168mc
100 173bz
100 173ch
100 173mc
100 178bz
100 178ch
100 178mc
100 178bz
100 178ch
100 178mc
100 840bz
100 840ch
100 840mc
100 841bz
100 841ch
100 841mc
100 842bz
100 842ch
100 842mc

BLING SCONCE II

100 169bz
100 169ch
100 169mc
100 174bz
100 174ch
100 174mc
100 179bz
100 179ch
100 179mc

BOLERO SCONCE

100 336bz
100 336ch
100 336mc
100 337bz
100 337ch
100 337mc
100 338bz
100 338ch
100 338mc
100 339bz
100 339ch
100 339mc

CHIANTI SCONCE

100 820bz
100 820ch
100 821bz
100 821ch
100 821mc
100 822bz
100 822ch
100 822mc
100 823bz
100 823ch
100 823mc

CIRO MINI SCONCE

100 830bz
100 830ch
100 830mc
100 831bz
100 831ch
100 831mc
100 832bz
100 832ch
100 833bz
100 833ch
100 833mc

SCONCES

TECHNICAL SPECIFICATIONS

Description: 4" Canopy with J-Box and Glass
Design: Bruck-Team
Lamp: 50 Watt GY6.35

CONTENTS OF DELIVERY

fixture complete without lamp

IMPORTANT SAFETY INSTRUCTIONS

1. Save these instructions and refer to them when additions to or changes to the fixture are made.
2. THIS PRODUCT MUST BE INSTALLED BY A PERSON FAMILIAR WITH THE CONSTRUCTION AND OPERATION OF THE PRODUCT AND THE HAZARDS INVOLVED, IN ACCORDANCE WITH THE APPLICABLE NEC CODE.
3. Do not install this fixture in damp or wet locations.
4. CAUTION - Do not install any fixture assembly closer than 6 inches from any curtain, or similar combustible material.
5. Turn off power prior to any work on the systems.
6. Warranty is void in case of unauthorized modifications and/ or improper use.

READ ALL OF THESE INSTRUCTIONS BEFORE INSTALLATION

INSTALLATION INSTRUCTIONS

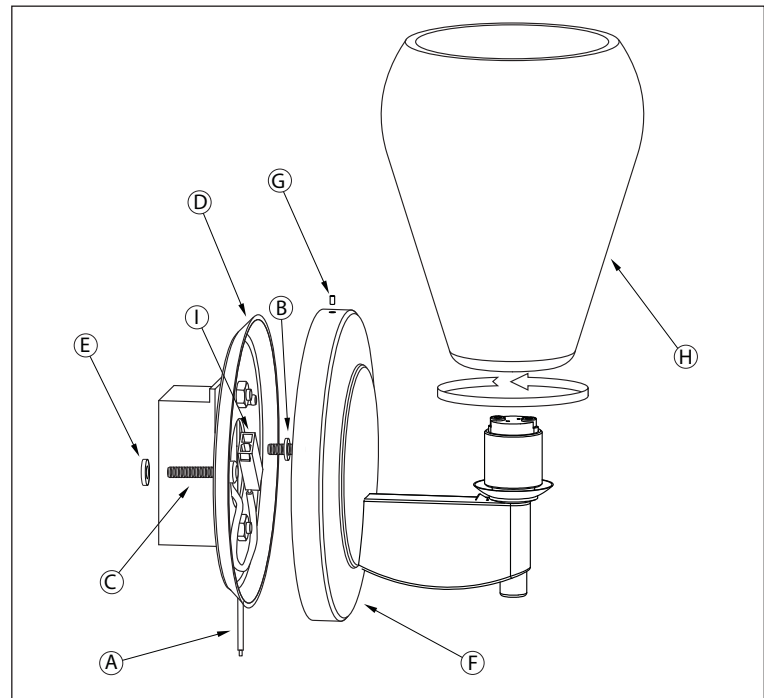

INSTRUCTIONS FOR USE

- The Sconce can be mounted directly to any wall with access to the power cables. Begin by connecting the two wires from the transformer (A) to the power cables in the wall. Then slide the notched plastic washer (B) through the mounting screw (C). Insert the screw (C) into the mounting plate (D) and slide the plastic washer (E) onto the end of the screw. Align the screws (C) with the J-box and tighten until firmly connected.

- Connect quick connect (I) then place the canopy cover (F) over the mounting plate (D) and secure it with the allen screw (G) located on the side of the base.

- Remove the glass shade (H) from the fixture by turning the glass counter-clockwise. Insert a Bi-Pin lamp into the socket head to complete the installation.

NOTE: Zara glass should not be removed.