

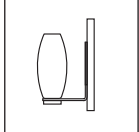

LED DIAMOND/ SQUARE SCONCES

	<b>CIRO MINI DIAMOND SCONCE</b> 103 830bz 103 831bz 103 832bz 103 833bz		<b>BOLERO DIAMOND SCONCE</b> 103 336bz 103 337bz 103 338bz 103 339bz
	<b>SIERRA DIAMOND SCONCE</b> 103 114bz		
	<b>CIRO DIAMOND SCONCE</b> 103 116bz 103 118bz 103 119bz 103 121bz 103 122bz 103 124bz 103 125bz		
	<b>LUCY DIAMOND SCONCE</b> 103 126bz 103 127bz 103 128bz		
	<b>CHIANTI DIAMOND SCONCE</b> 103 820bz 103 821bz 103 822bz 103 823bz		
	<b>BLING DIAMOND SCONCE</b> 103 168bz 103 176bz 103 178bz 103 840bz 103 841bz 103 842bz		
	<b>BLING DIAMOND SCONCE II</b> 103 169bz 103 174bz 103 179bz		
	<b>BOBO DIAMOND SCONCE</b> 103 915bz 103 917bz		
	<b>RAINBOW DIAMOND SCONCE</b> 103 721bz 103 722bz 103 723bz 103 724bz 103 913bz 103 918bz		
	<b>RAINBOW DIAMOND SCONCE II</b> 103 725bz 103 726bz 103 728bz 103 729bz 103 816bz 103 817bz 103 916bz 103 919bz		

LAMP TYPE: 3W LED

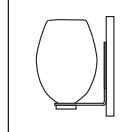
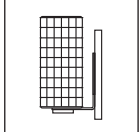
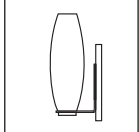
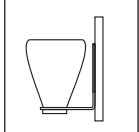
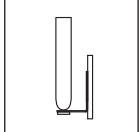
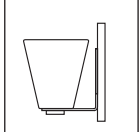

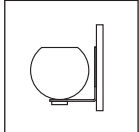
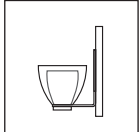
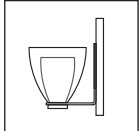
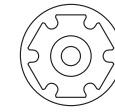
**CIRO MINI DIAMOND SCONCE**  
103 830bz  
103 831bz  
103 832bz  
103 833bz

**SIERRA DIAMOND SCONCE**  
103 114bz

**CIRO DIAMOND SCONCE**  
103 116bz  
103 118bz  
103 119bz  
103 121bz  
103 122bz  
103 123bz  
103 124bz  
103 125bz

**LUCY DIAMOND SCONCE**  
103 126bz  
103 127bz  
103 128bz

**BOBO DIAMOND SCONCE**  
103 915bz  
103 917bz

**BLING DIAMOND SCONCE**  
103 168bz  
103 173bz  
103 178bz  
103 840bz  
103 841bz  
103 842bz

**BLING DIAMOND SCONCE II**  
103 169bz  
103 174bz  
103 179bz

**BOLERO DIAMOND SCONCE**  
103 336bz  
103 337bz  
103 338bz  
103 339bz

**RAINBOW DIAMOND SCONCE**  
103 721bz  
103 722bz  
103 723bz  
103 724bz  
103 913bz  
103 918bz

**RAINBOW DIAMOND SCONCE II**  
103 725bz  
103 726bz  
103 728bz  
103 729bz  
103 816bz  
103 817bz  
103 916bz  
103 919bz

**CHIANTI DIAMOND SCONCE**  
103 820bz  
103 821bz  
103 822bz  
103 823bz

LED DIAMOND/ SQUARE SCONCES

TECHNICAL SPECIFICATIONS

Description: 4" Canopy with J-Box and Glass  
Design: Bruck-Team  
Lamp: 3 Watt LED

CONTENTS OF DELIVERY  
fixture complete

**IMPORTANT SAFETY INSTRUCTIONS**

1. Save these instructions and refer to them when additions to or changes to the fixture are made.
2. THIS PRODUCT MUST BE INSTALLED BY A PERSON FAMILIAR WITH THE CONSTRUCTION AND OPERATION OF THE PRODUCT AND THE HAZARDS INVOLVED, IN ACCORDANCE WITH THE APPLICABLE NEC CODE.
3. Do not install this fixture in damp or wet locations.
4. CAUTION - Do not install any fixture assembly closer than 6 inches from any curtain, or similar combustible material.
5. Turn off power prior to any work on the systems.
6. Warranty is void in case of unauthorized modifications and/ or improper use.

READ ALL OF THESE INSTRUCTIONS BEFORE INSTALLATION

INSTALLATION INSTRUCTIONS

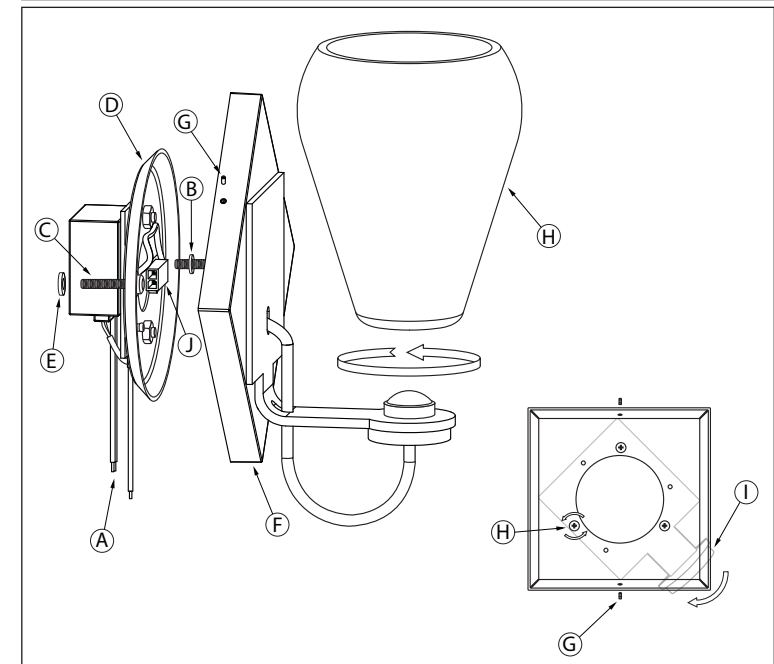

INSTRUCTIONS FOR USE

- Begin by connecting the two wires from the transformer (A) to the power cables in the wall. Then slide the notched plastic washer (B) through the mounting screw (C).
- Insert the screw (C) into the mounting plate (D) and slide the plastic washer (E) onto the end of the screw. Align the screws (C) with the J-box and tighten until firmly connected.
- Connect quick connect (I) then place the canopy cover (F) over the mounting plate (D) and secure it with the allen screw (G) located on the side of the base.

Changing Diamond Canopy to Square

- To rotate stem, unscrew (G) from the canopy cover (F). Unscrew all 3 screws (H) from the back of canopy, rotate stem (I) and align with holes.
- Remove the glass shade (H) from the fixture by turning the glass counter-clockwise.