

ENZIS NV-SCHIENENSYSTEM

D



CLASSIC / FREE

ART.-NO. 140 700
140 701

GEBRAUCHSANLEITUNG

D

TECHNISCHE DATEN

Material : Messing/Kunststoff
Oberfläche : matt verchromt/silber
Leuchterspannung : 12V SELV
Lampenleistung : max. 20 W
Sockel : G 4
Leuchtmittel : QT 9 in Niederdrucktechnik



Schutzklasse:



! ALLGEMEINE SICHERHEITSHINWEISE !

- Bei allen Arbeiten an System und Leuchten **Anlage spannungsfrei schalten!!**
- Nicht zur Installation in Feuchträumen geeignet.
- Bei der Montage des Systems dürfen nur systemeigene Bauteile verwendet werden.
- Achtung, Gefahr durch Stromschlag !!** System und Leuchten **niemals** ohne Trafo direkt an die **Netzspannung** anschließen!!
- Es liegt in der Verantwortung des Benutzers, die elektrische, mechanische und thermische Verträglichkeit zwischen dem System und den daran angebrachten Leuchten sicherzustellen.
- Vorsicht!** Leuchte und Leuchtmittel werden in Betrieb heiß.
- Den angegebenen Mindestabstand der Leuchtmittel zu brennbaren Gegenständen beachten!
(siehe Leuchte ☞ ¶)
- chtung:** Zur Verminderung der Gefahr von Überhitzung und Feuer keine Leiter überbrücken.
- Kein Garantianspruch bei eigenmächtigen Veränderungen und oder unsachgemäßer Benutzung!

LIEFERUMFANG

1 CLASSIC / FREE komplett ohne Leuchtmittel

EMPFOHLENES ZUBEHÖR

BALL
DIFFUSOR
SCHIRM
SEGEL
APOLLOS DECO
SILVA DECO



ENZIS LV TRACK SYSTEM

GB



CLASSIC / FREE

ART.-NO. 140 700
140 701

INSTRUCTIONS FOR USE

GB

SPECIFICATIONS

Materials: brass/plastic
Surface: matt chrome-plated/silver
Lamp voltage: 12 V SELV
Lamp wattage: max. 20 W
Lamp socket: G 4
Bulb: QT 9 in low pressure technique



Protective class :



! GENERAL REMARKS ON SAFETY !

- Switch off power to the system** for all work on the system and on lamps!!
- Not suitable for installation in wet rooms.
- For assembly of the system, only systemowned components must be used.
- Attention, electric shock hazard!! Never** connect the system and lamps without transformer directly to the **mains voltage!**
- It is within the responsibility of the user to ensure the electrical, mechanical and thermal compatibility between the system and lamps mounted to it.
- Take care! Lamp and illuminant become hot during operation.
- Observe the stated minimum distance of the illuminants to flammable objects! (see lamp ☞ ¶)
- Attention:** In order to minimise the risk of overheating or fire do not bypass any conductors.
- No warranty claim in case of unauthorized modifications and / or improper use!

SCOPE OF DELIVERY

1 CLASSIC / FREE complete without illuminant

RECOMMENDED ACCESSORIES

BALL
DIFFUSOR
SCHIRM
SEGEL
APOLLOS DECO
SILVA DECO



ENZIS SYSTÈME À BAS VOLTAGE

F



CLASSIC / FREE

ART.-NO. 140 700
140 701

MODE D'EMPLOI

F

DATES TECHNIQUES

Matériaux: laiton/matière plastique
Surface: chromé en mate/argent
Voltage de lampe: 12 V SELV
Wattage de lampe: max. 20 W
Douille: G 4
Ampoule: QT 9 en technique de basse pression



Type de protection:



! CONSIGNES DE SECURITE GENERALES !

- Avant d'effectuer tout travail sur le système et les luminaires **mettre l'installation hors tension**
- N'est pas approprié à être installé dans des pièces humides
- Lors du montage du système n'utilisez que les composants spécifiques de la gamme.
- Attention danger d'électrocution !! Ne jamais** raccorder le système ou les luminaires directement sur le réseau sans le transformateur!
- L'utilisateur est responsable d'assurer la compatibilité électrique, mécanique et thermique entre le système et les luminaires qui s'y rapportent.
- Attention !** Les luminaires et les lampes sont brûlantes lors de leur utilisation.
- Veiller à respecter l'intervalle minimum indiqué des lampes par rapport à des objets inflammables.
(voir luminaires ☞ ¶)
- Attention:** afin de minimiser les risques de surchauffe et d'incendie, ne pas court-circuiter les conducteurs.
- Nous ne donnons aucune garantie lors de modifications effectuées sur l'installation ou lors d'une utilisation inadéquate.

ETENDUE DE LIVRAISON

1 CLASSIC / FREE complet sans lampe

ACCESSOIRES RECOMMANDÉS

BALL
DIFFUSOR
SCHIRM
SEGEL
APOLLOS DECO
SILVA DECO

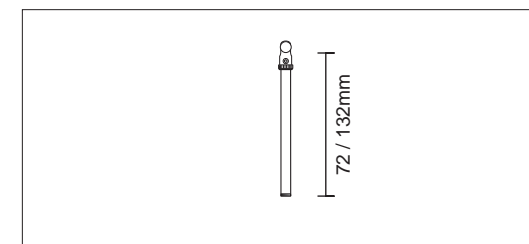
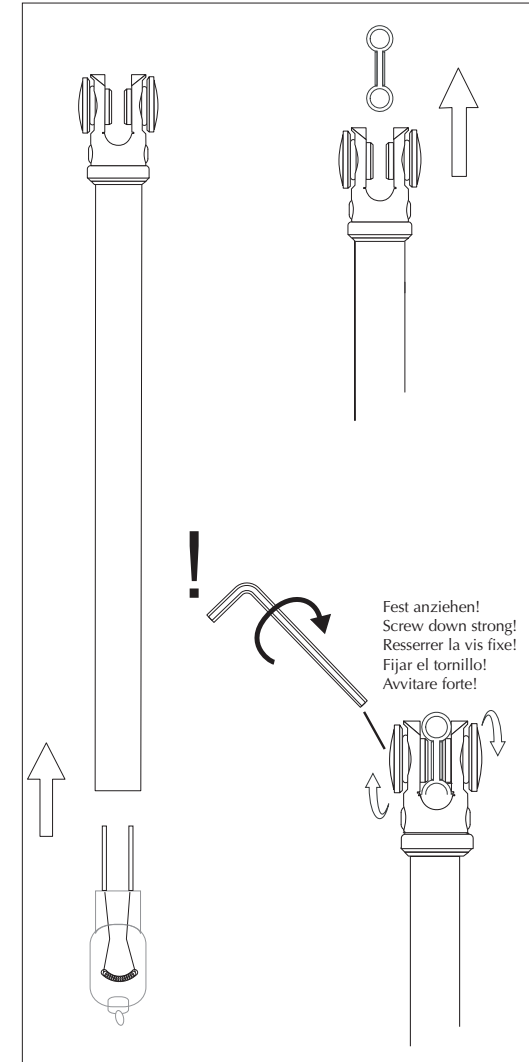

BRUCK.



ENZIS SISTEMA DE BAJO VOLTAJE 



	CLASSIC / FREE ART.-NO. 140 700 140 701
---	--

MODO DE EMPLEO 

ESPECIFICACIONES TÉCNICAS

Materiales:	latón/material sintético
Superficie:	cromado en mate/plata
Voltaje de lámpara:	12 V SELV
Wataje de lámpara:	max. 20 W
Portalámparas:	G 4
Bombilla:	QT 9 en técnica de baja presión

 Clase de protección: 

 **INDICACIONES GENERALES DE SEGURIDAD** 

1. ¡En todos los trabajos a llevar a cabo en el sistema y las lámparas ha de mantenerse la **instalación libre de tensión!**
2. El sistema no es apropiado para la instalación en locales húmedos.
3. En el montaje del sistema solamente deben emplearse piezas constructivas del propio sistema.
4. **¡Atención peligro de electrocución!**
¡El sistema y las lámparas no deben conectarse **nunca** directamente a la **tensión de red** sin transformador!
5. Es responsabilidad del usuario asegurar la compatibilidad eléctrica, mecánica y térmica entre el sistema y las lámparas empleadas en él.
6. **¡Cuidado!** Las lámparas y las bombillas o reflectores se calientan durante el funcionamiento.
7. ¡Ha de observarse la distancia mínima indicada de las bombillas o reflectores respecto de los objetos combustibles! (véase la lámpara ).
8. **Atención:** no puentee ningún conductor eléctrico para así disminuir el riesgo de sobrecalentamiento e incendio.
9. ¡Se pierden las reivindicaciones de garantía al llevar modificaciones a cabo por propia cuenta y/o empleo incorrecto!

VOLUMEN DE SUMINISTRO
1 CLASSIC / FREE completo sin bombilla.

ACCESORIOS RECOMENDADOS
BALL
DIFFUSOR
SCHIRM
SEGEL
APOLLOS DECO
SILVA DECO



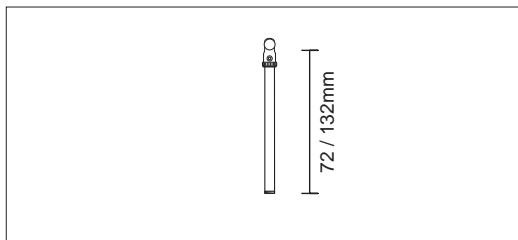
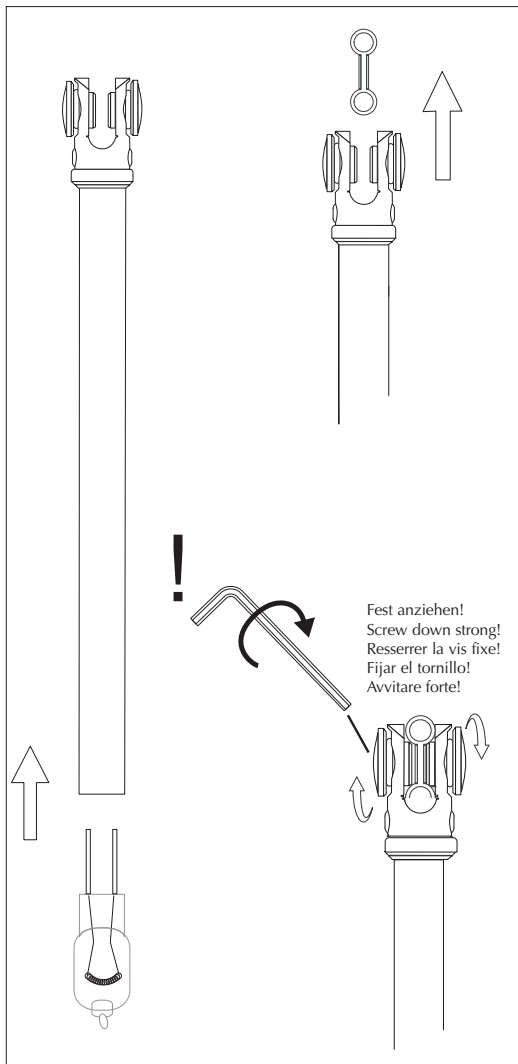



ENZIS SISTEMA A BASSO VOLTAGGIO 



	CLASSIC / FREE ART.-NO. 140 700 140 701
---	--

ISTRUZIONI PER L'USO 

DATI TECNICI

Materiale:	ottone/materiale sintetico
Superficie:	cromato allentato/argento
Voltaggio di lampada:	12 V SELV
Wattaggio di lampada:	max. 20 W
Portalampade:	G 4
Lampadina:	QT 9 in tecnica di bassa pressione

 Tipo di protezione: 

 **AVVERTENZE GENERALI PER LA SICUREZZA** 

1. Per tutti i lavori sul sistema e sulle lampade **eliminare la tensione dall'impianto!!**
2. Non adatto per l'installazione in locali umidi.
3. Per il montaggio del sistema vanno utilizzati esclusivamente componenti del sistema e della ditta BRUCK.
4. **Attenzione, pericolo di scosse di corrente !!** Non collegare il sistema e la lampada **mai** direttamente alla **tensione della rete** senza trasformatore!
5. L'utente è responsabile di assicurare la tollerabilità elettrica, meccanica e termica tra il sistema e le lampade applicate.
6. **Attenzione!** La lampada ed il mezzo illuminante scottano quando funzionanti.
7. Osservare la distanza minima indicata del mezzo illuminante da oggetti combustibili! (vedi lampada ).
8. **Attenzione:** al fine di ridurre il rischio di surriscaldamento e incendio, non cavallottare i conduttori.
9. Nessun diritto di garanzia in caso di modifiche apportate di propria iniziativa e / o di utilizzo inappropriato!

VOLUME DELLA FORNITURA
1 CLASSIC / FREE completo senza mezzo illuminante

ACCESORII RACCOMANDATI
BALL
DIFFUSOR
SCHIRM
SEGEL
APOLLOS DECO
SILVA DECO



PLANUNGSHILFE
PLANNING AIDS
AIDE DE PLANIFICATION
AYUDA DE PLANIFICACIÓN
AIUTO DI PLANIFICAZIONE

